

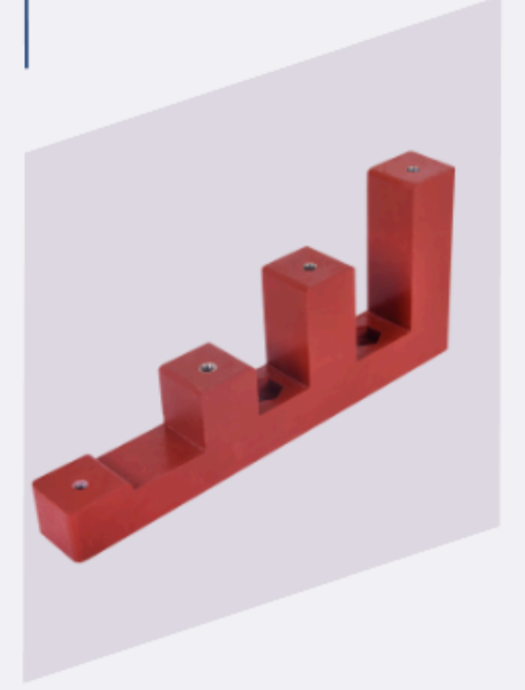

PRODUCT CATALOGUE

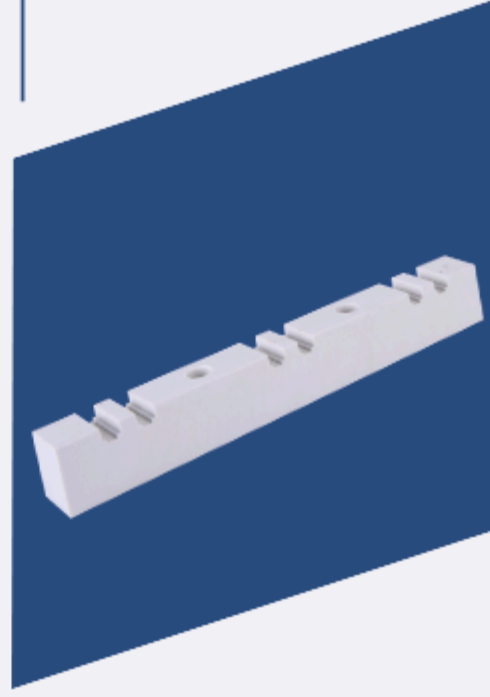

www.teknikelektrik.info.tr

Istanbul, TURKEY

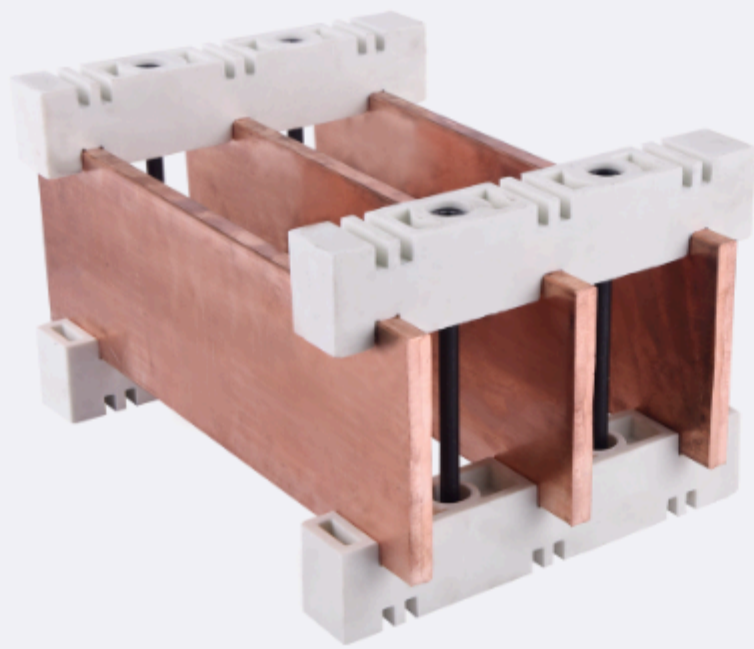

- LV Insulators
- Busbar Supports
- UP-GM 203 / GPO3 Composite Insulation sheets
- FR-4 Epoxy Resin Insulation sheets
- Filament winding composite tubes

2025



1kV Pin Type Insulators

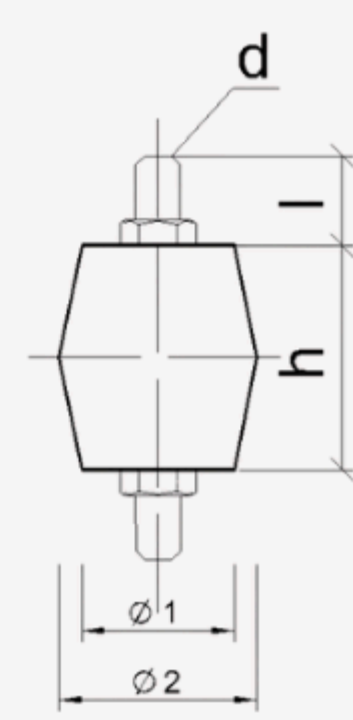

- pin-type insulators made of glass fibre reinforced BMC
- for interiors - switchboards
- colour: red or white
- brass or steel blind nuts & male threads galvanised

ORDER CODE	SPECIFICATIONS	COLOUR	DIMENSIONS(mm.)					OPERATING VOLTAGE (kV)	TEST VOLTAGE (kV)	TENSILE FORCE (kN)	PRESS FORCE (kN)	FLEXURAL FORCE (Nm)
			h	l	d	Q1	Q2					
001725050101	MI-0.0/S--M5 Two sides brass blind nuts	RED	25	10	M5	17	22	0,6	3	2	6	0,6
001725050201	MI.0.0/C--M5 Two sides bolts	RED	25	10	M5	17	22	0,6	3	2	6	0,6
001725050301	MI-0.0/S+C--M5 One side bolted+one side brass blind nuts	RED	25	10	M5	17	22	0,6	3	2	6	0,6
104040080101	MI-1.0/S (M8)--M8 Two sides brass blind nuts	RED	40	15	M8	32	40	1	6	6	10	1
104040080201	MI-1.0/C (M8)--M8 Two sides bolts	RED	40	15	M8	32	40	1	6	6	10	1
104040080301	MI-1.0/S+C (M8)--M8 One side bolted+one side brass blind nuts	RED	40	15	M8	32	40	1	6	6	10	1
104040100101	MI-1.0/S (M10)--M10 Two sides brass blind nuts	RED	40	15	M10	32	40	1	6	10	14	2
104040100201	MI-1.0/C (M10)--M10 Two sides bolts	RED	40	15	M10	32	40	1	6	10	14	2
104040100301	MI-1.0/S+C (M10)--M10 One side bolted+one side brass blind nuts	RED	40	15	M10	32	40	1	6	10	14	2

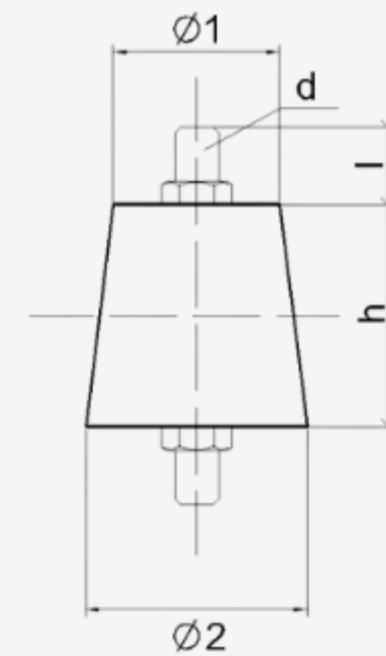

- pin-type insulators made of glass fibre reinforced BMC
- for interiors - switchboards
- colour: red or white
- brass or steel blind nuts & male threads galvanised

ORDER CODE	SPECIFICATIONS	COLOUR	DIMENSIONS(mm.)					OPERATING VOLTAGE (kV)	TEST VOLTAGE (kV)	TENSILE FORCE (kN)	PRESS FORCE (kN)	FLEXURAL FORCE (Nm)
			h	l	d	Q1	Q2					
023225060101	MI-0.2/S--M6 Two sides brass blind nuts	RED	25	10	M6	21	32	0,6	3	2	6	0,6
023225060201	MI-0.2/C--M6 Two sides bolts	RED	25	10	M6	21	32	0,6	3	2	6	0,6
023225060301	MI-0.2/S+C--M6 One side bolted+one side brass blind nuts	RED	25	10	M6	21	32	0,6	3	2	6	0,6
124040080101	MI-1.2/S (M8)--M8 Two sides brass blind nuts	RED	40	15	M8	32	40	1	6	6	10	1
124040080201	MI-1.2/C (M8)--M8 Two sides bolts	RED	40	15	M8	32	40	1	6	6	10	1
124040080301	MI-1.2/S+C (M8)--M8 One side bolted+one side brass blind nuts	RED	40	15	M8	32	40	1	6	6	10	1
124040100101	MI-1.2/S (M10)--M10 Two sides brass blind nuts	RED	40	15	M10	32	40	1	6	10	14	2
124040100201	MI-1.2/C (M10)--M10 Two sides bolts	RED	40	15	M10	32	40	1	6	10	14	2
124040100301	M-1.2/S+C (M10)--M10 One side bolted+one side brass blind nut	RED	40	15	M10	32	40	1	6	10	14	2

1-3 kV Pin Type Insulators

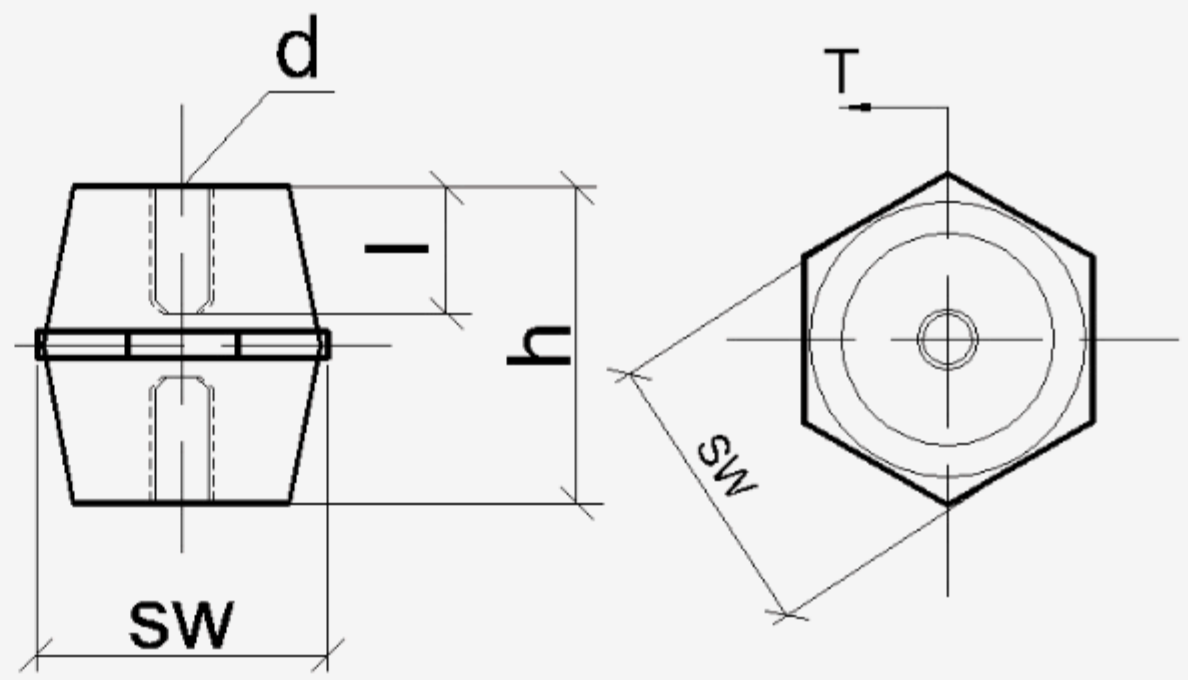

- pin-type insulators made of glass fibre reinforced BMC
- for interiors - switchboards
- colour: red or white
- brass or steel blind nuts

ORDER CODE	SPECIFICATIONS	COLOUR	DIMENSIONS (mm.)				OPERATING VOLTAGE (kV)	TEST VOLTAGE (kV)	T TORQUE (Nm)	F BREAKING FORCE (kN)	G TRACTION (kN)	P PRESS FORCE (kN)
			h	l	d	sw						
112125060101	AKMI-625--Spanner flat, M6 Brass blind nuts, h: 25 mm.	RED / WHITE	25	7	M6	21	1	10	15	1,50	5	35
113230060101	AKMI-630--Spanner flat, M6 Brass blind nuts, h: 30 mm.	RED / WHITE	30	8	M6	32	1	15	20	2,50	6	45
113230080101	AKMI-830--Spanner flat, M8 Brass blind nuts, h: 30 mm.	RED / WHITE	30	8	M8	32	1	15	20	2,50	6	45
113335060101	AKMI-635--Spanner flat, M6 Brass blind nuts, h: 35 mm.	RED / WHITE	35	10	M6	33	1	15	20	2,00	6	45
113335080101	AKMI-835--Spanner flat, M8 Brass blind nuts, h: 35 mm.	RED / WHITE	35	10	M8	33	1	15	20	3,50	12	60
113335100101	AKMI-1035--Spanner flat, M10 Brass blind nuts, h: 35 mm.	RED / WHITE	35	10	M10	33	1	15	20	4,00	12	60
114040080101	AKMI-840--Spanner flat, M8 Brass blind nuts, h: 40 mm.	RED / WHITE	40	14	M8	40	2	20	40	3,00	12	60
114040100101	AKMI-1040--Spanner flat, M10 Brass blind nuts, h: 40 mm.	RED / WHITE	40	14	M10	40	2	20	50	3,00	12	60
114045080101	AKMI-845--Spanner flat, M8 Brass blind nuts, h: 45 mm.	RED / WHITE	45	14	M8	40	2	20	40	4,00	12	60
114045100101	AKMI-1045--Spanner flat, M10 Brass blind nuts, h: 45 mm.	RED / WHITE	45	14	M10	40	2	20	50	4,00	12	60
114650100101	AKMI-1050--Spanner flat, M10 Brass blind nuts, h: 50 mm.	RED / WHITE	50	14	M10	46	3	25	90	5,00	20	90
114650120101	AKMI-1250--Spanner flat, M12 Brass blind nuts, h: 50 mm.	RED / WHITE	50	14	M12	46	3	25	100	5,00	22	100
114051080101	AKMI-851--Spanner flat, M8 Brass blind nuts, h: 51 mm.	RED / WHITE	51	14	M8	46	3	25	40	5,00	12	90
114051100101	AKMI-1051--Spanner flat, M10 Brass blind nuts, h: 51 mm.	RED / WHITE	51	14	M10	46	3	25	90	5,00	20	100
115060100101	AKMI-1060--Spanner flat, M10 Brass blind nuts, h: 60 mm.	RED / WHITE	60	20	M10	50	3	25	90	6,00	20	100
115060120101	AKMI-1260--Spanner flat, M12 Brass blind nuts, h: 60 mm.	RED / WHITE	60	20	M12	50	3	25	120	6,00	20	100
115076100101	AKMI-1076--Spanner flat, M10 Brass blind nuts, h: 76 mm.	RED / WHITE	76	25	M10	50	3	25	200	11,00	32	240
115076120101	AKMI-1276--Spanner flat, M12 Brass blind nuts, h: 76 mm.	RED / WHITE	76	25	M12	50	3	25	300	15,00	37	240

1-3 kV Big Type Insulators

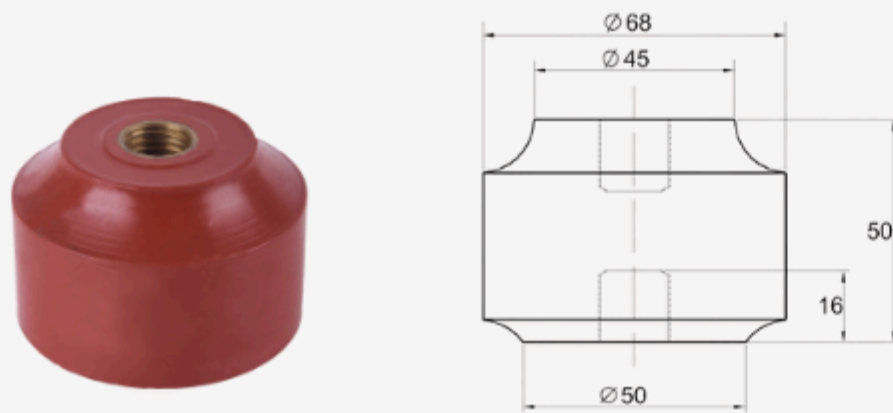

1N-B (M16)

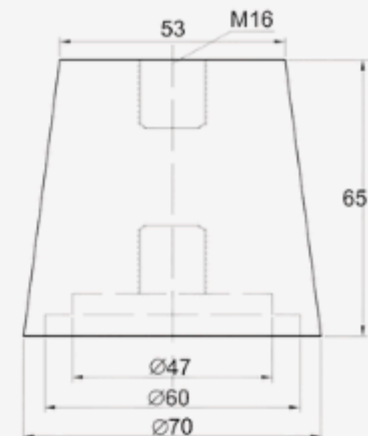

1N-K (M16)

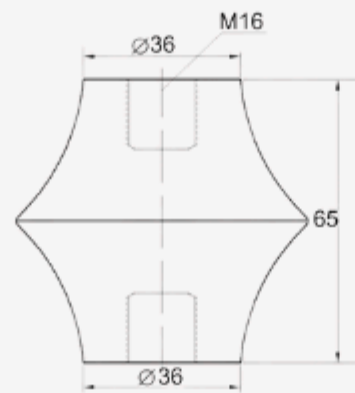

1N-C (M16)

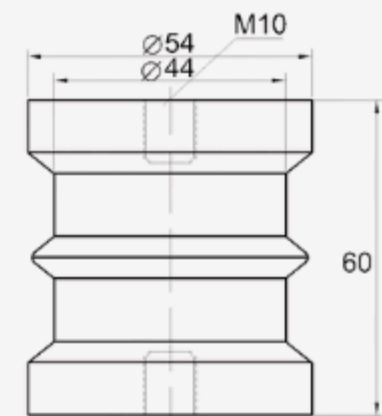

1N-500 (M8/M10)

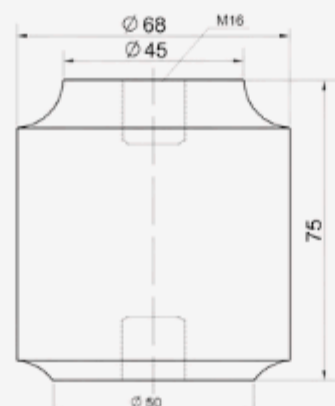

1N-D (M16)

- 1-3 kV big insulators made of glass fibre reinforced BMC
- for interiors - switchboards
- colour: red
- brass or steel blind nuts

Busbar Supports

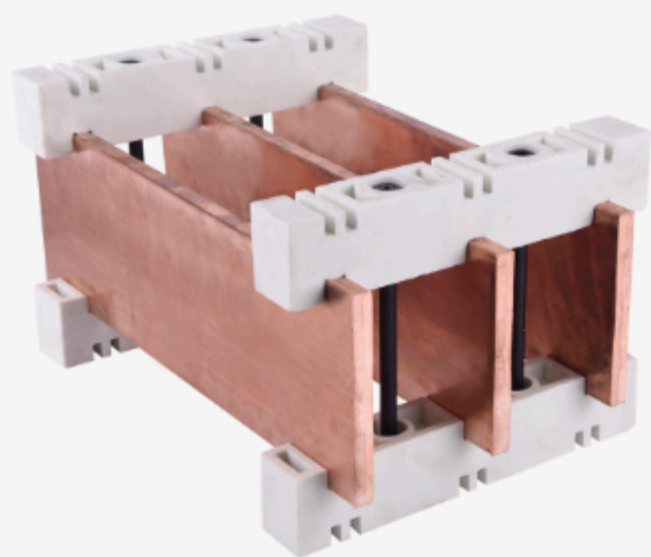

- Busbar supports made of glass fibre reinforced BMC
- for interiors - switchboards
- colour: red

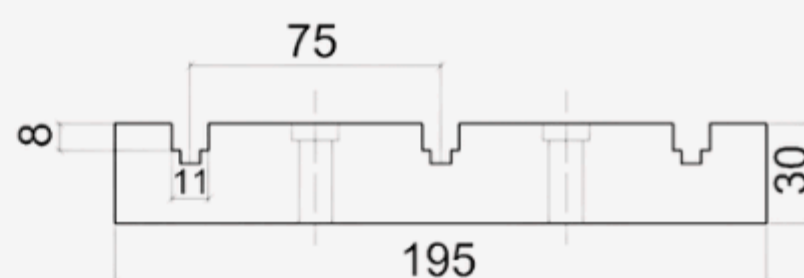

DBT-3x1FB Busbar Support / Order Code: 20010101

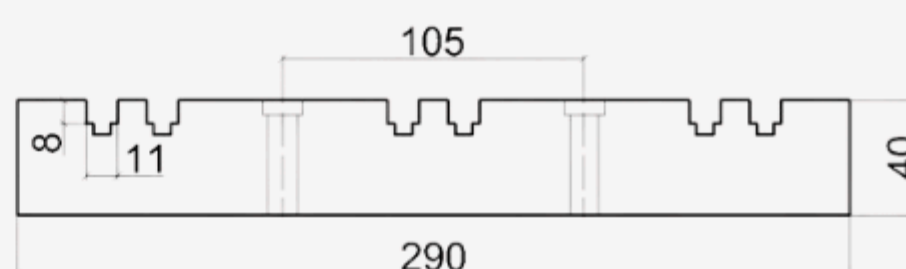
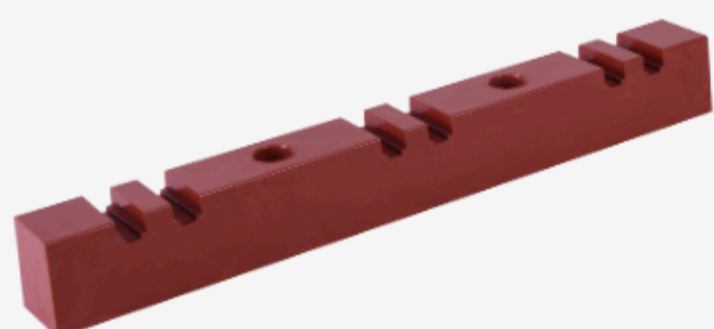

DBT-3x2FB Busbar Support / Order Code: 20020101

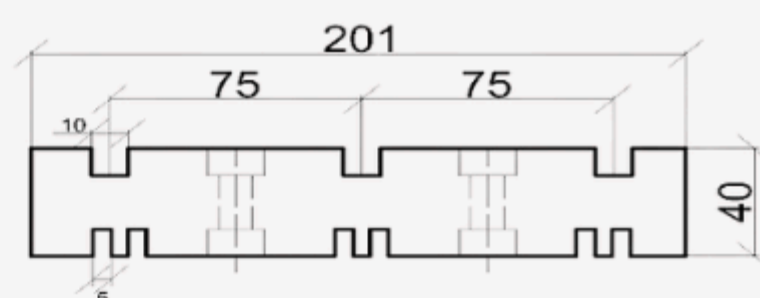
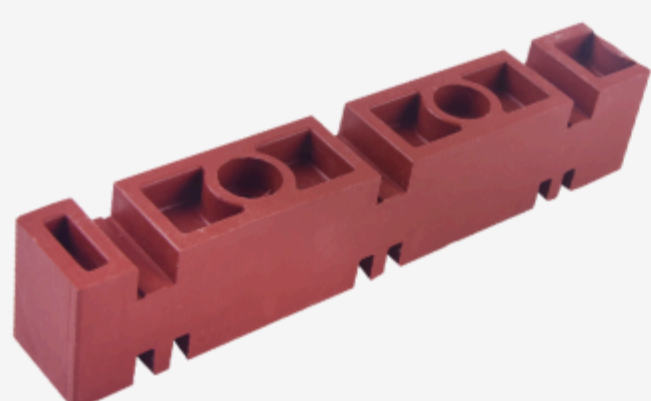

DBT-3x1FB/M Multi Series Busbar Support / Order Code: 20050101

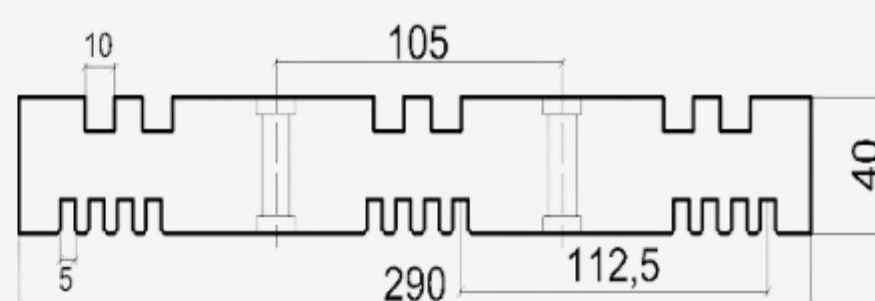
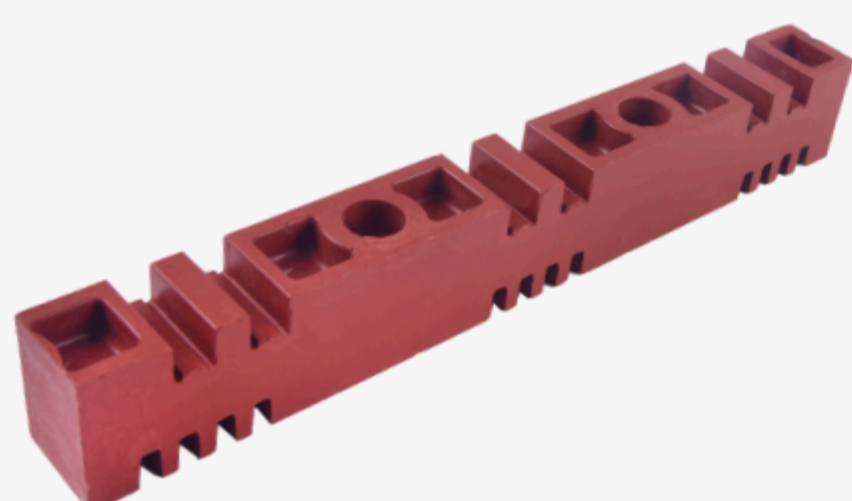

DBT-3x2FB/M Multi Series Busbar Support / Order Code: 20060101

Busbar Supports +Neutral

- Busbar supports made of glass fibre reinforced BMC
- for interiors - switchboards
- colour: red

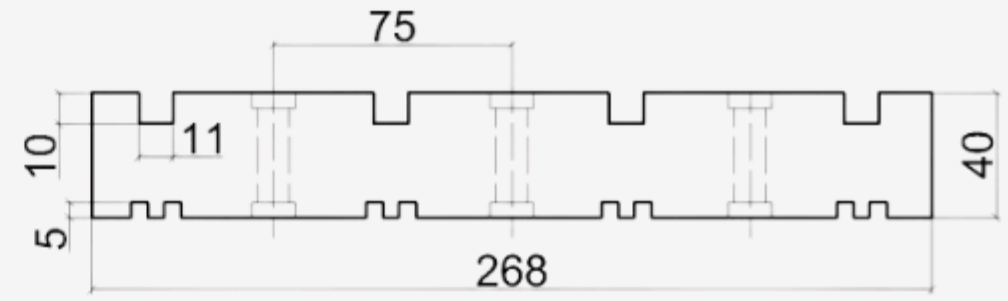

DBT-3x1F+NB Busbar Support / Order Code: 20010201
three phase with Neutral

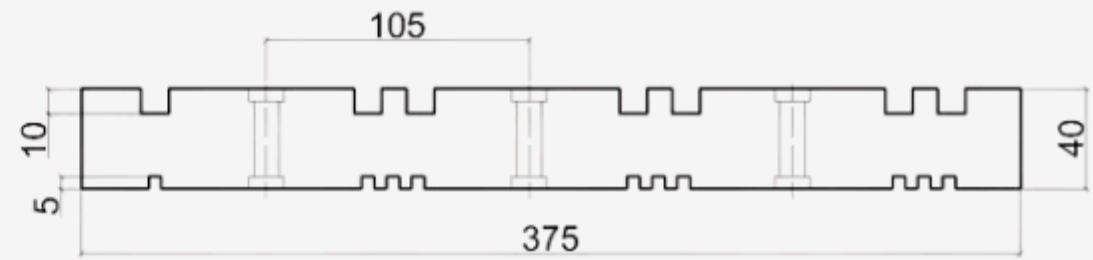
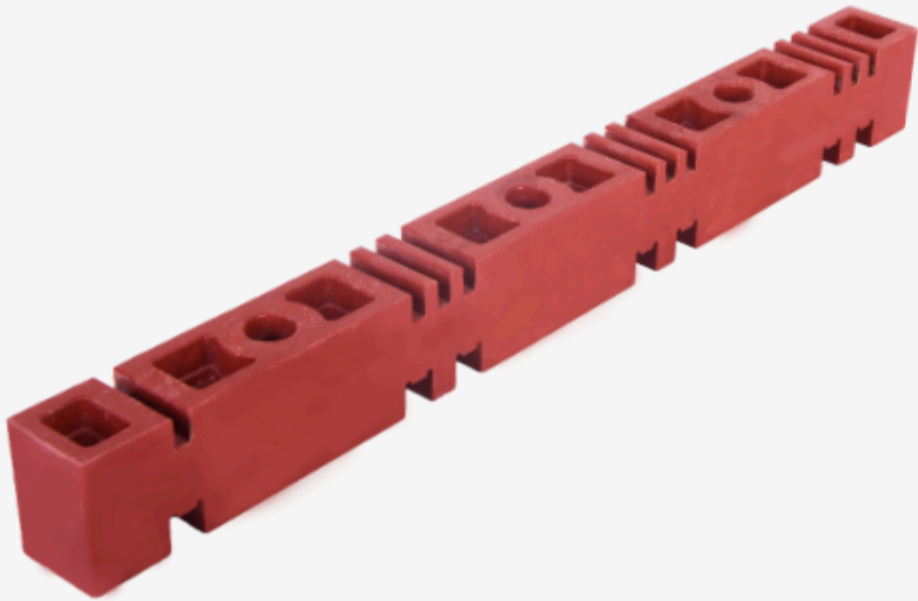

DBT-3x2F+NB Busbar Support / Order Code: 20020201

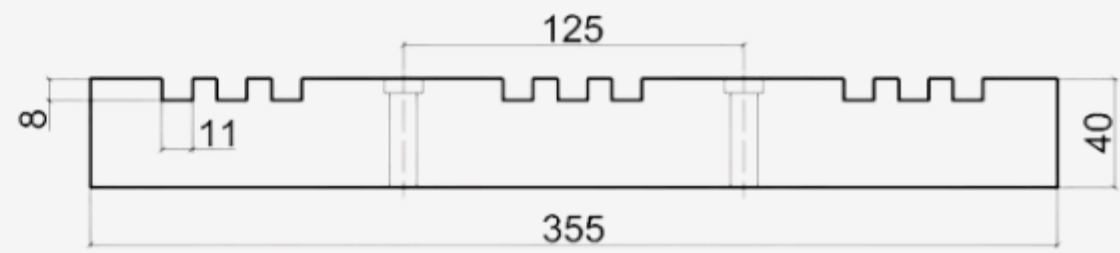
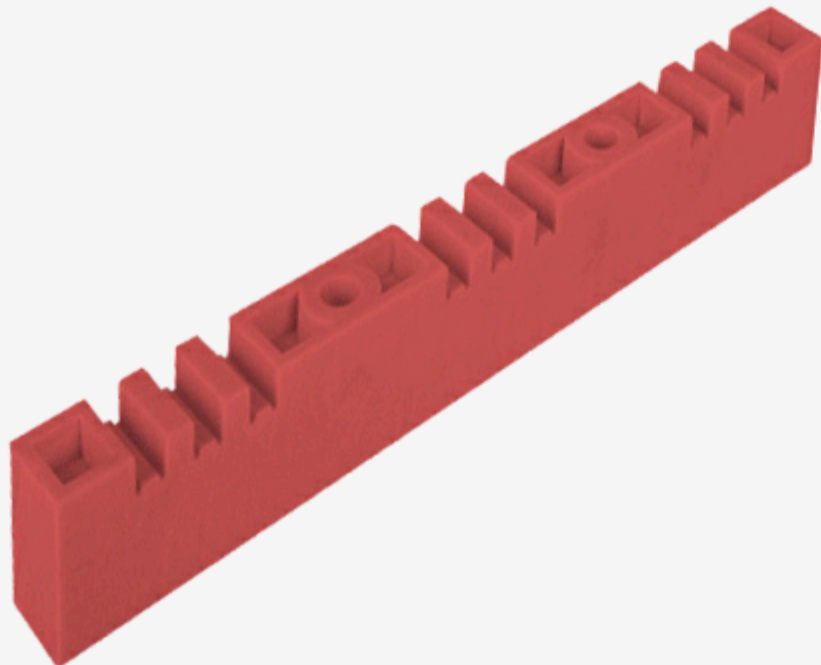

DBT-3x3FB (125 mm.) Busbar Support
Order Code: 20030101

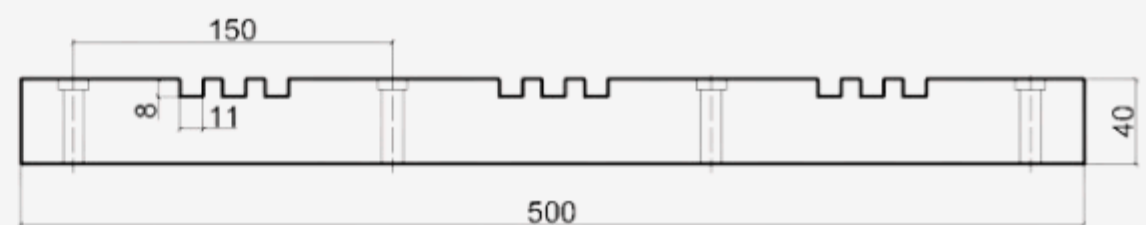

DBT-3x3FB (150 mm.) Busbar Support
Order Code: 20040101

100 kA Type Tested
Busbar Supports

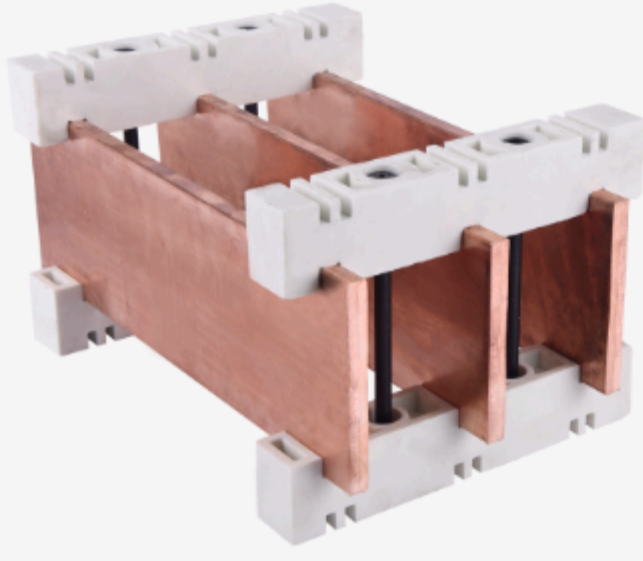

- 100 kA short circuit type tested acc. to TS-EN 61439-1
- Busbar supports made of glass fibre reinforced SMC
- for interiors - switchboards
- colour: RAL 7035

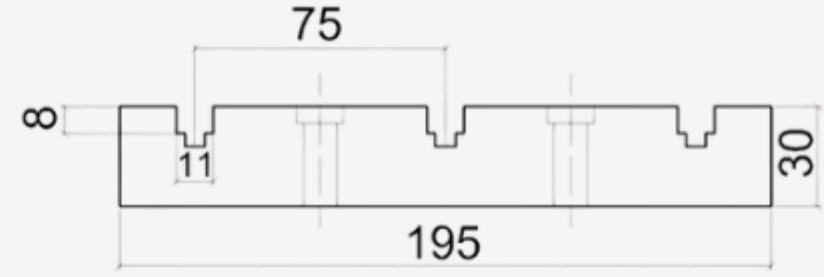
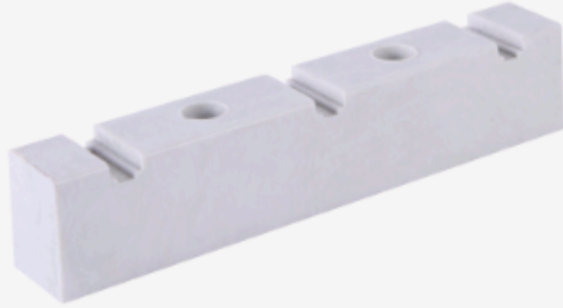

DBT-3x1FS Busbar Support / Order Code: 20010102

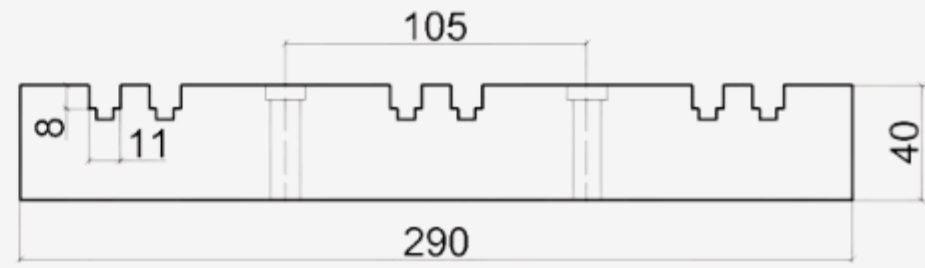

DBT-3x2FS Busbar Support / Order Code: 20020102

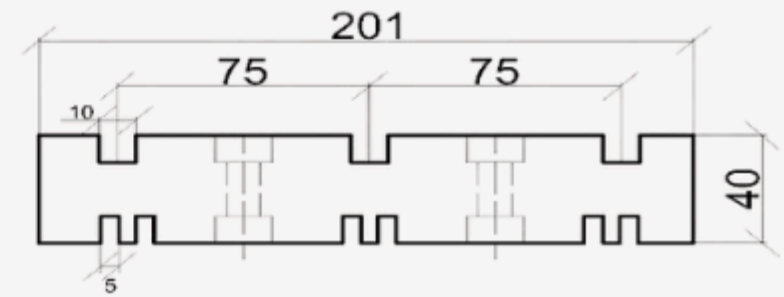
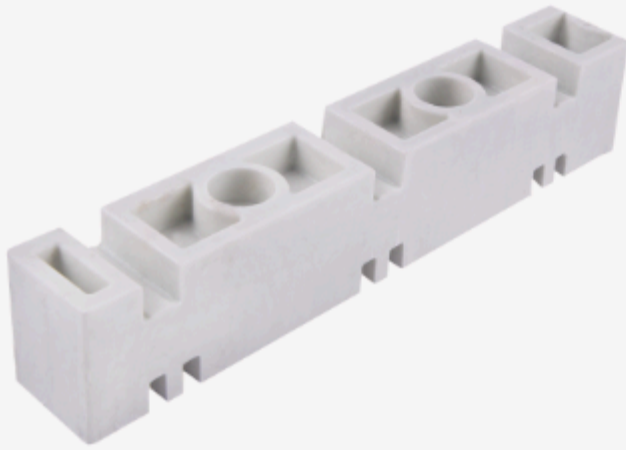

DBT-3x1FS/M Multi Series Busbar Support / Order Code: 20050102

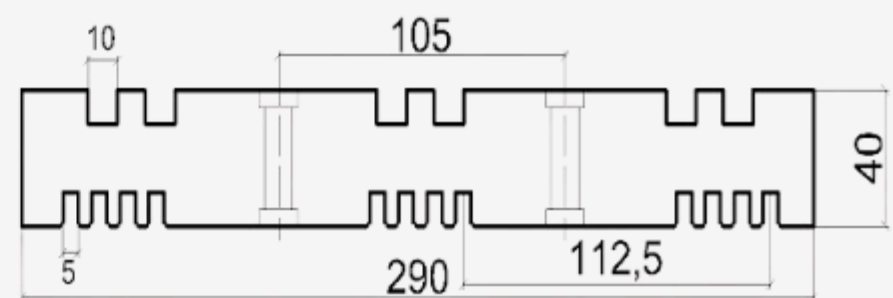
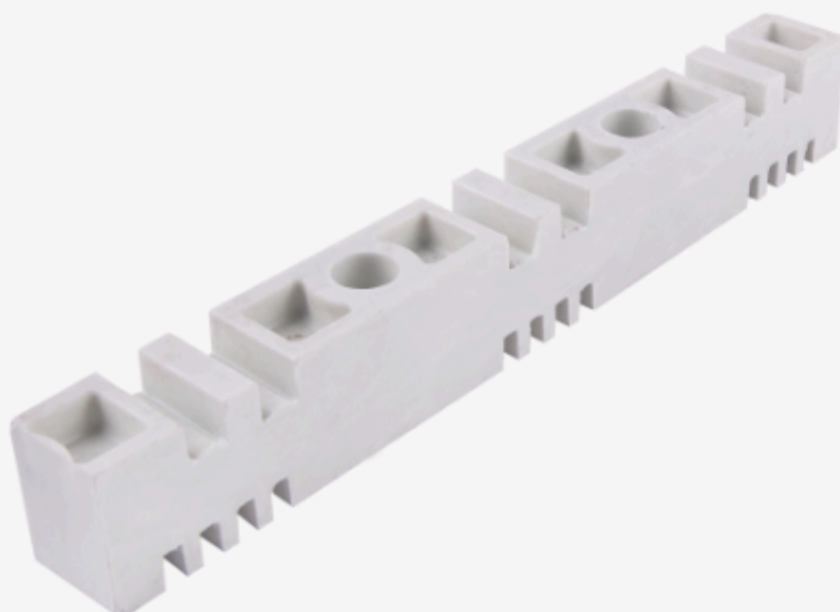

DBT-3x2FS/M Multi Series Busbar Support / Order Code: 20060102

100 kA Type Tested
Busbar Supports
+Neutral

- 100 kA short circuit type tested acc. to TS-EN 61439-1
- Busbar supports made of glass fibre reinforced SMC
- for interiors - switchboards
- colour: RAL 7035

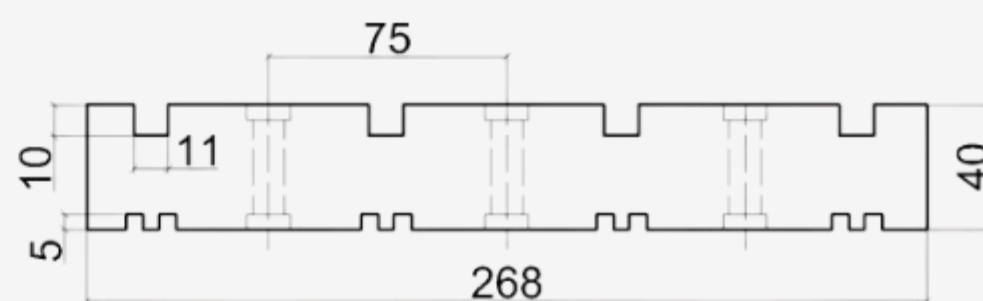

DBT-3x1F+NS Busbar Support / Order Code: 20010202

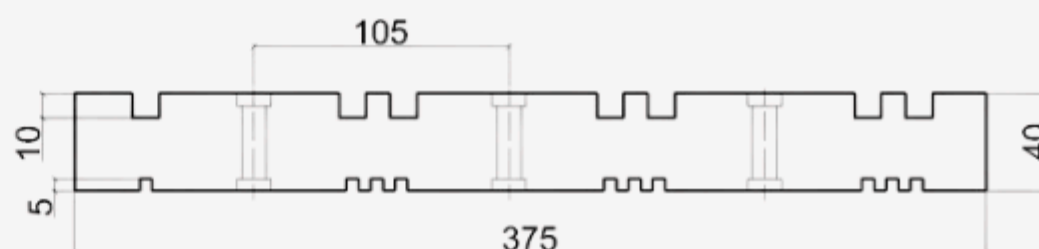
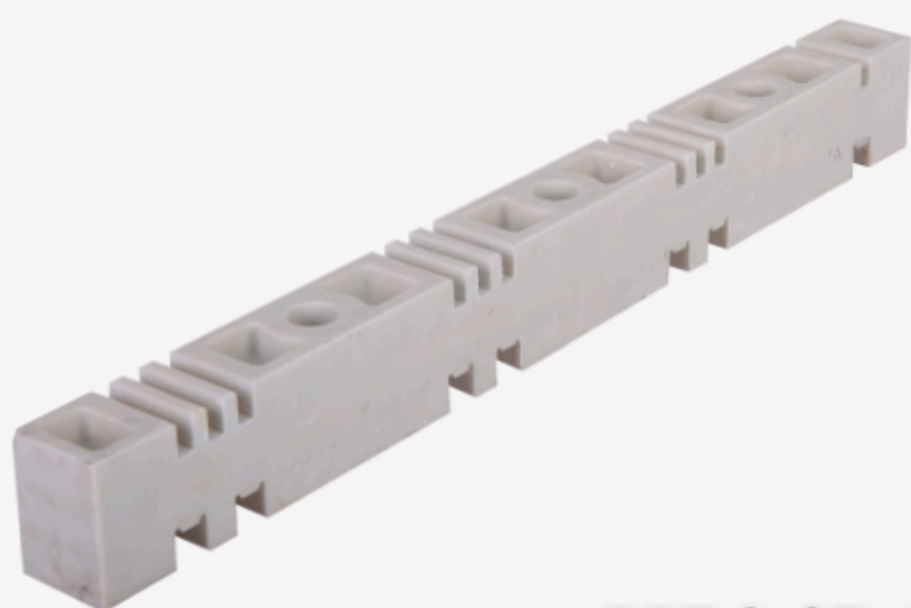

DBT-3x2F+NS Busbar Support / Order Code: 20020202

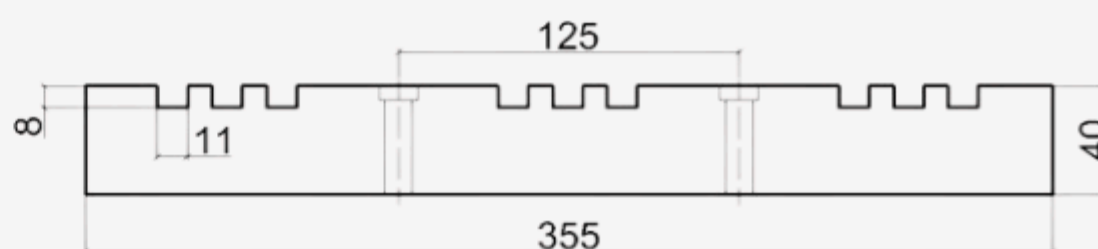
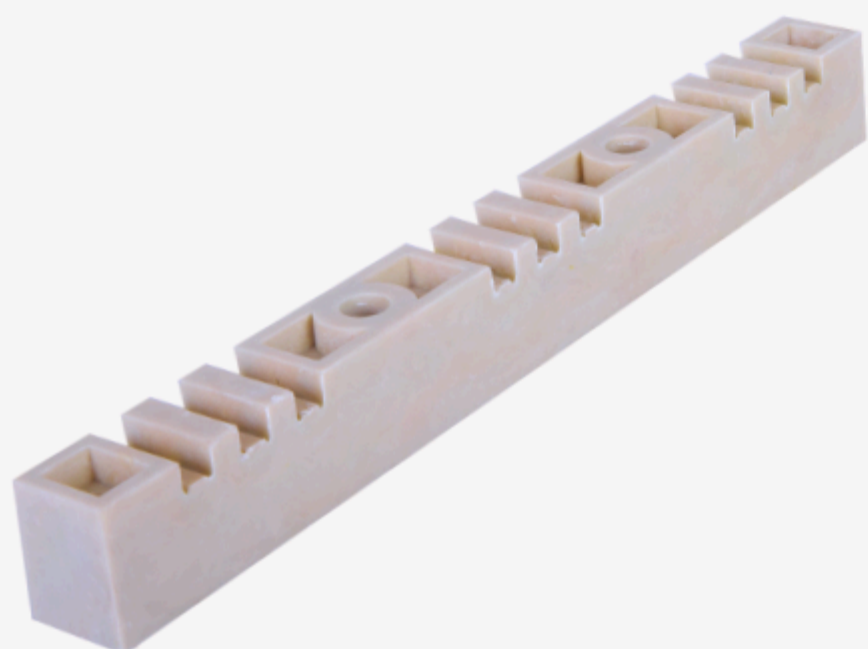

DBT-3x3FS (125 mm.) Busbar Support
Order Code: 20030102

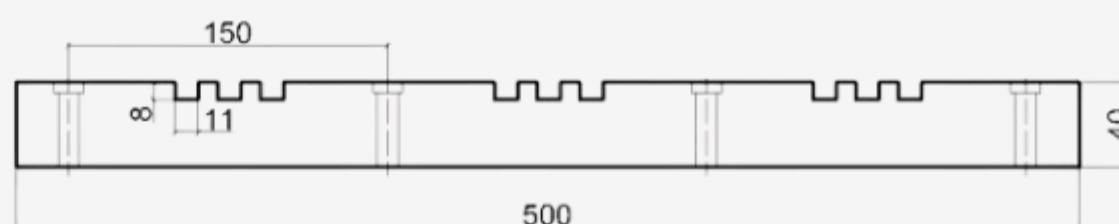

DBT-3x3FS (150 mm.) Busbar Support
Order Code: 20040102

Single Phase Busbar Supports

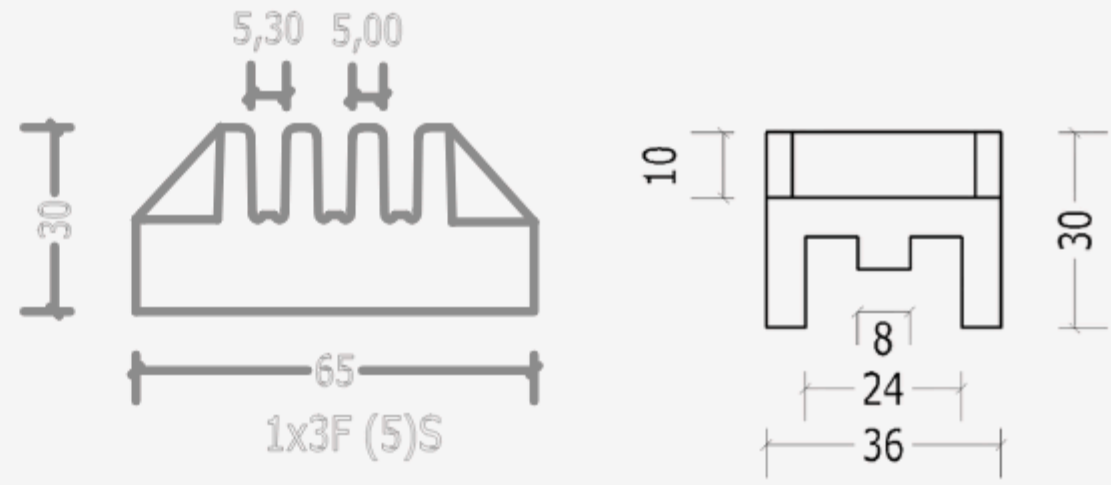

1x3F(5)S Busbar Support / Order Code: 30010102

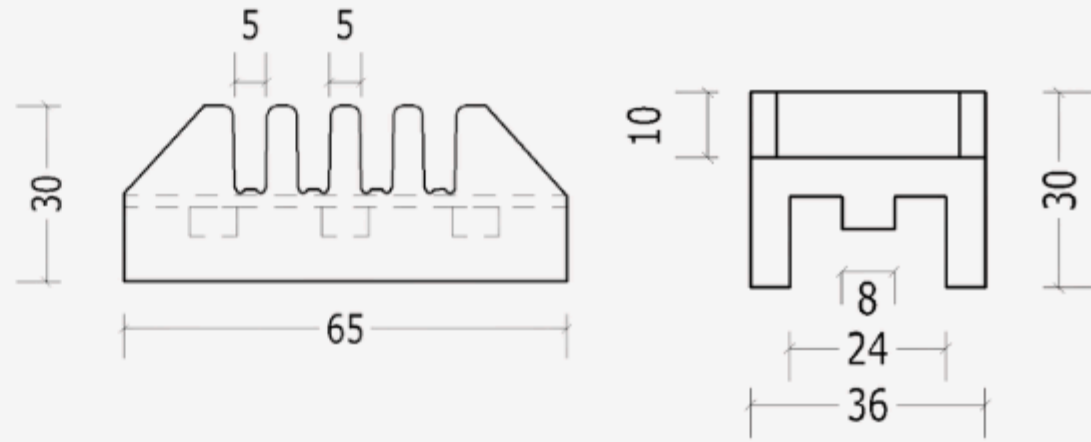

1x4F(5)S Busbar Support / Order Code: 35010102

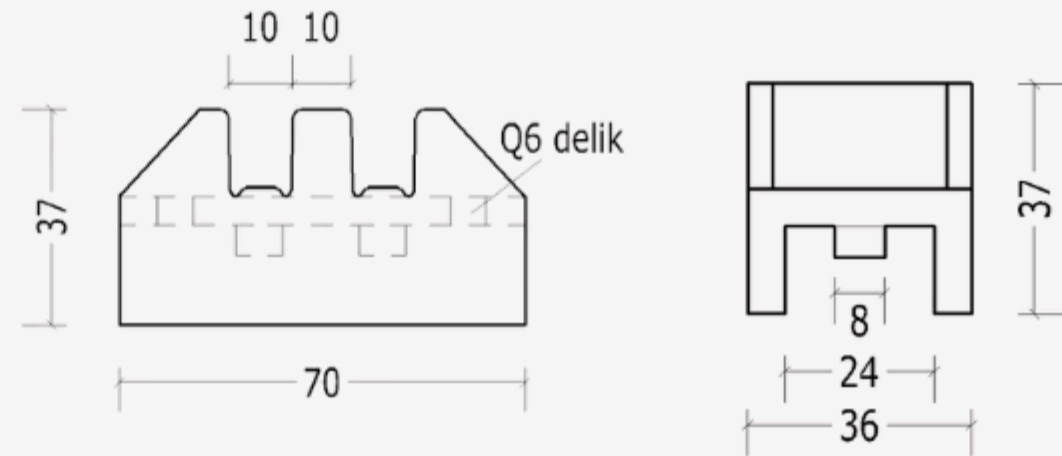

1x2F(10)S Busbar Support / Order Code: 35020102

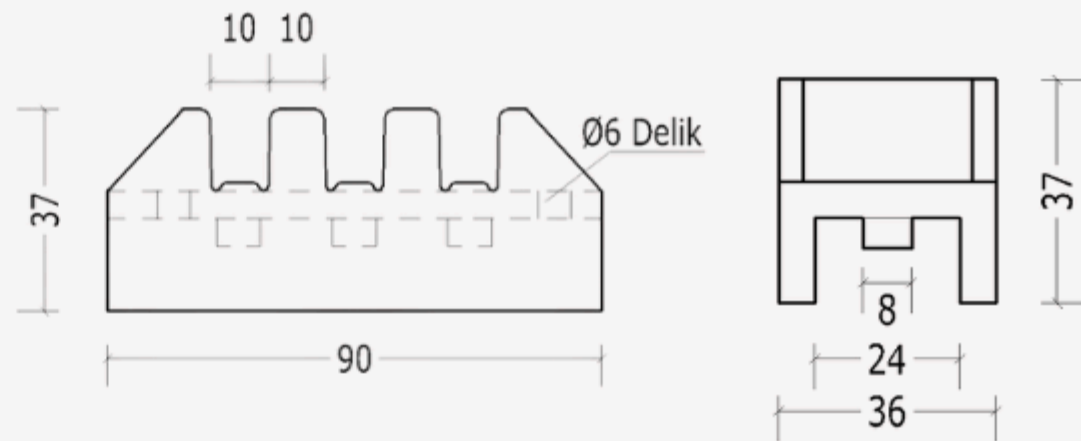

1x3F(10)S Busbar Support / Order Code: 35030102

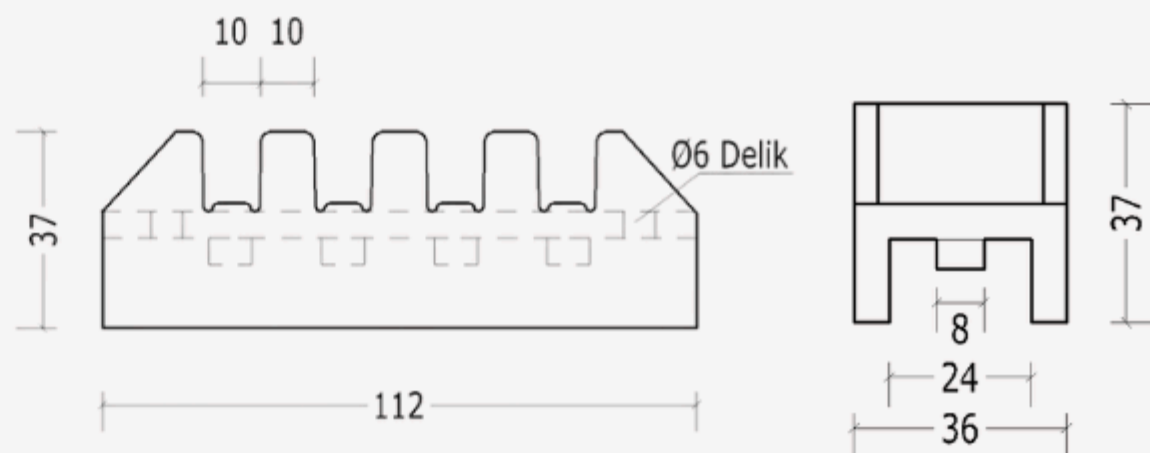

1x4F(10)S Busbar Support / Order Code: 35040102

Single Phase Busbar Supports

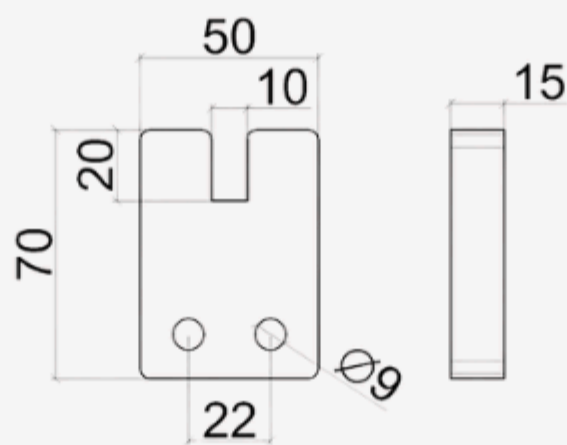
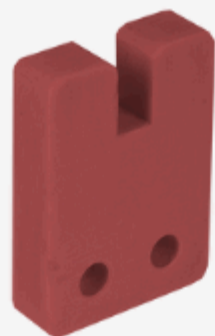

TET-110B (10 mm.)
Order Code : 40010101



TET-110S (10 mm.)
Order Code : 40010102

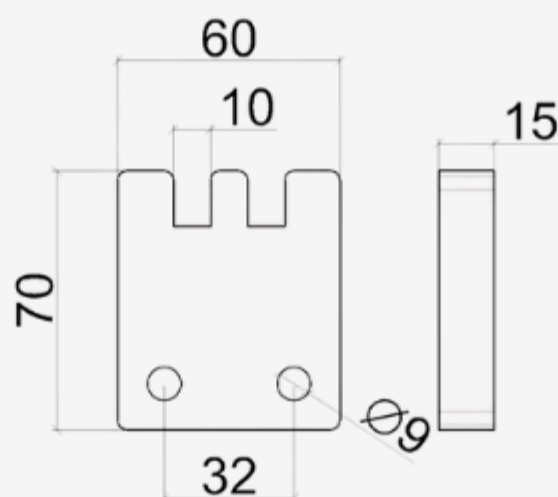
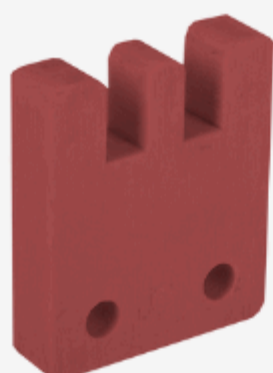

TET-210B (10 mm.)
Order Code : 40020101



TET-210S (10 mm.)
Order Code : 40020102

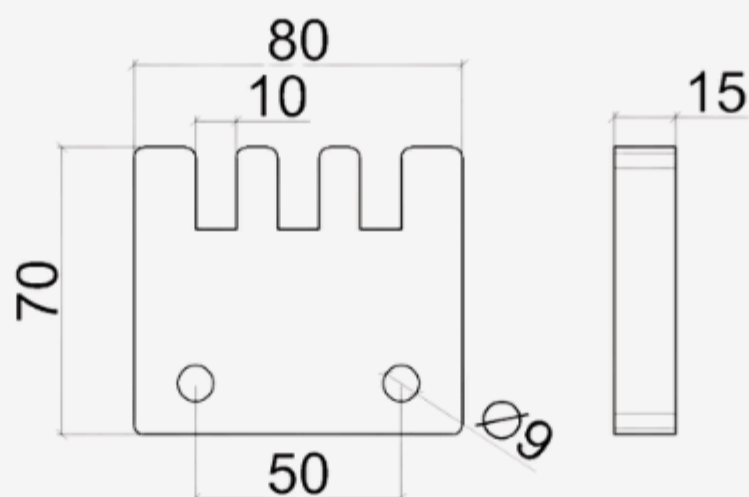
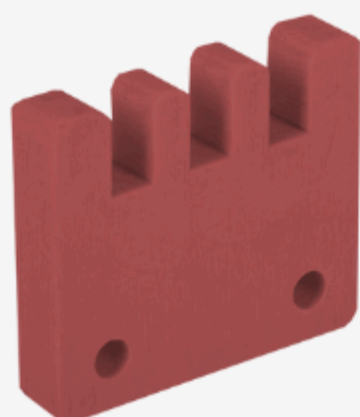

TET-310B (10 mm.)
Order Code : 40030101

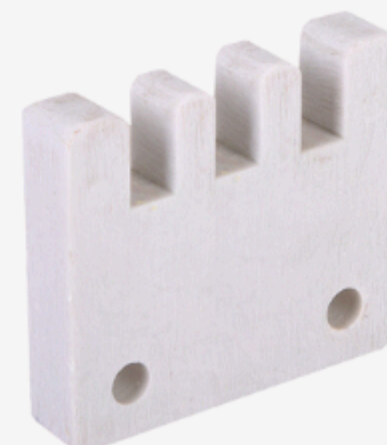

TET-310S (10 mm.)
Order Code : 40030102

Step Insulators

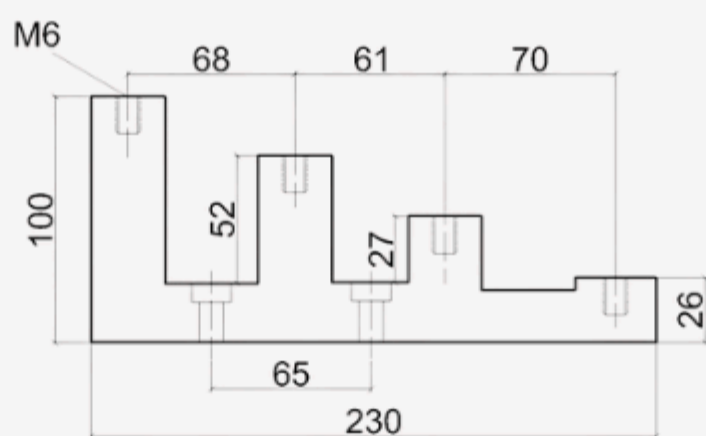
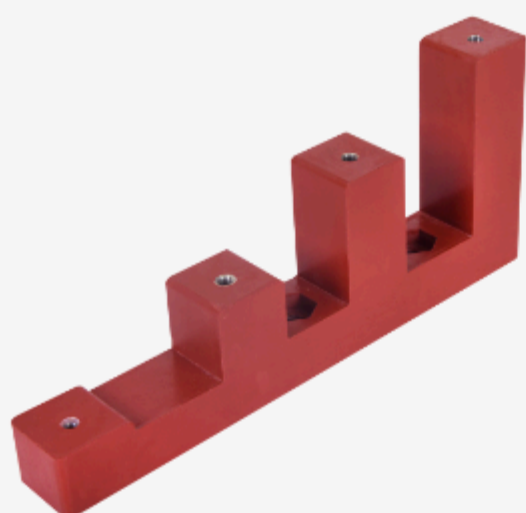

M.İZ-M6B Step Insulator
Order Code : 25010101

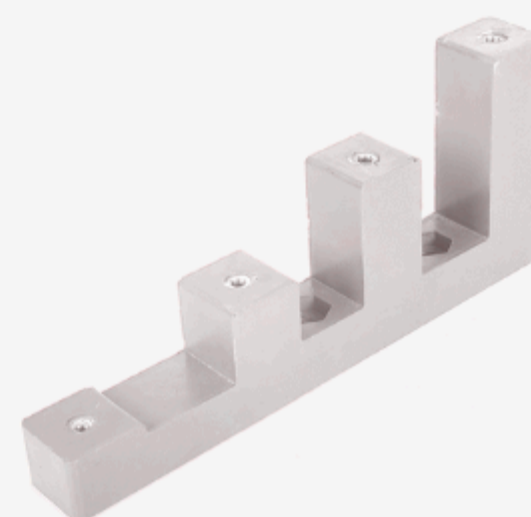

M.İZ-M6S Step Insulator
Order Code : 25010102

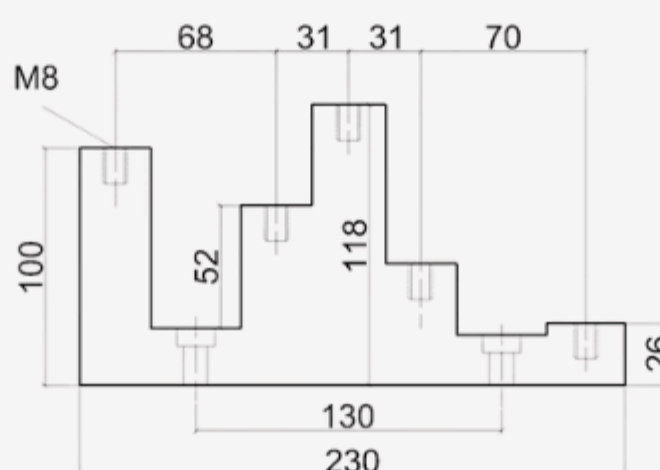
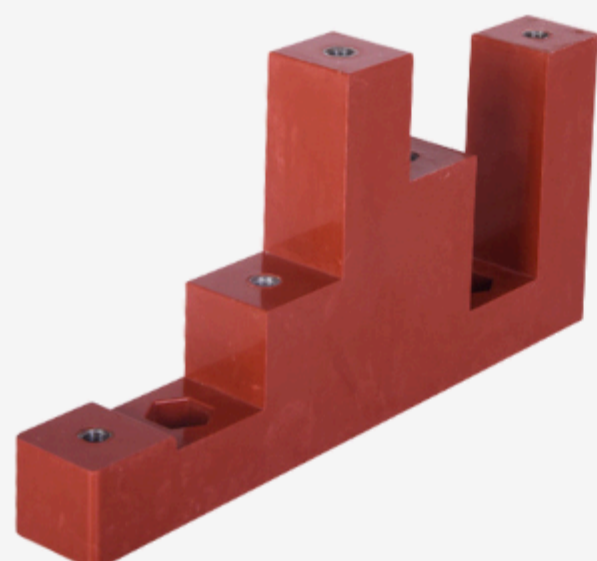

NM.İZ-M8B Step Insulator
Order Code : 26010101



NM.İZ-M8S Step Insulator
Order Code : 26010102

CERTIFICATES



2025





MLS TEKNİK ELEKTRİK SAN. TİC. A.Ş.

Battalgazi Mah. Bostancı Sok. 1B1/23 34935
Sultanbeyli/İSTANBUL - TURKEY

T : +90 216 592 74 77

F : +90 216 592 02 14

www.teknikelektrik.info.tr

info@teknikelektrik.info.tr